

INPUT-UNIT

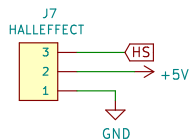

POWER-UNIT

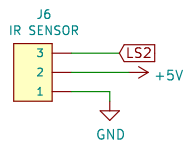
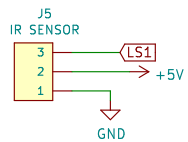
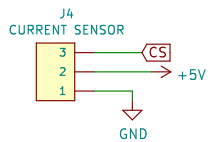
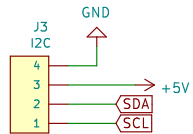
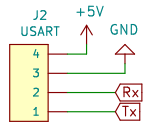
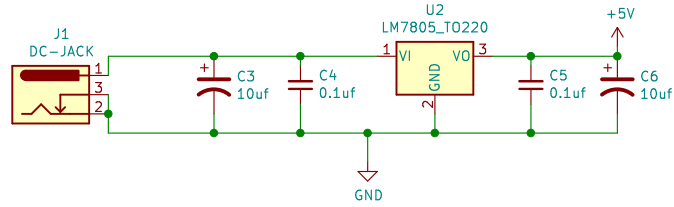

MICROCONTROLLER

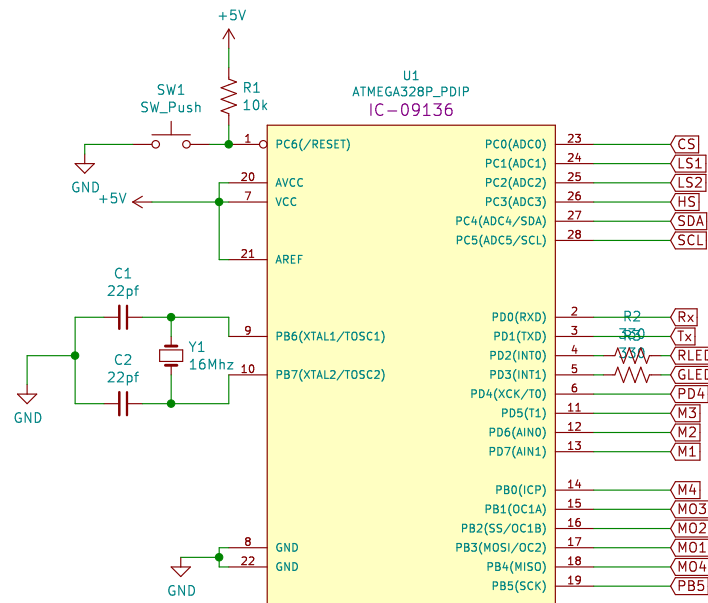

OUTPUT-UNIT

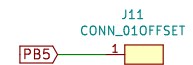
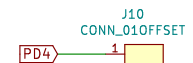
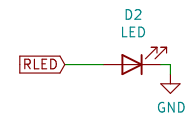
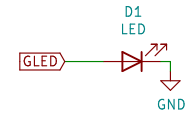

Designe By ; FARHAN ASHRAF
ASHRAF

Sheet: /
 File: atmega328p.sch

Title: Atmega328

Size: A4 Date: 23-01-2021

KiCad E.D.A. kicad (5.1.6)-1

Rev:
 Id: 1/1